

User Manual



www.hotpoint.eu/register



THANK YOU FOR BUYING A HOTPOINT PRODUCT.

In order to receive a more complete assistance, please register your appliance on www.hotpoint.eu/register



Before using the appliance carefully read the Safety Instruction.

Before using the machine, it is imperative that the transport bolts are removed. For more detailed instructions on how to remove them, see the Installation Guide.

CONTROL PANEL

- 1 "ON/OFF" button
- 2 Programme selector
- 3 "Start/Pause" button
- 4 "Spin Speed" button
- 5 "Multi Rinse" button
- 6 "Cleaning Action" button
- 7 "Start Delay" button
- 8 "Energy saver"/"Key lock" button
- 9 "Temperature" button

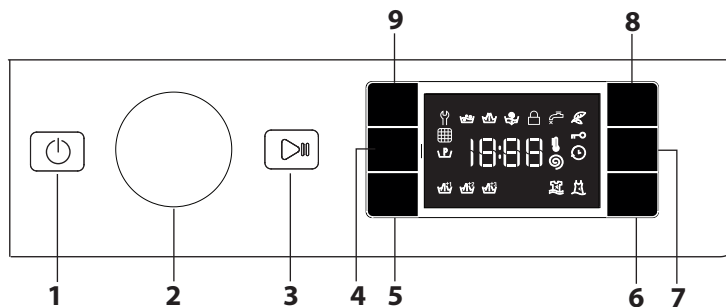

DISPLAY INDICATORS

- Door locked
- Energy saver activated
- Pre-wash activated

- Start Delay activated
- Key lock activated
- Washing phase
- Indicates washing phase of the cycle
- Failure: Call Service
- Refer to Troubleshooting section
- Failure: Water filter clogged
- Water cannot be drained; water filter might be blocked
- Failure: No water
- No or not sufficient inlet water.
- In the event of any failure, refer to the "TROUBLESHOOTING" section

PROGRAMME CHART

Maximum load 7 kg Power input in off mode 0.5 W / in left-on mode 8 W						Detergents and Additives			Recommended detergent		Residual dampness %	Energy consumption kWh	Total water l	
Wash cycle	Temperature		Maximum spin (r.p.m.)	Maximum load (kg)	Duration (minutes)	Pre-wash	Wash	Fabric softener	Powder	Liquid				
	Default	Range				1	2	3						
1	Anti Stain 100	40 °C	☼ - 40 °C	1400	7,0	**	-	●	○	✓	-	-	-	-
2	Anti Stain Quick	40 °C	☼ - 40 °C	1200	3,5	**	-	●	○	-	✓	-	-	-
3	White	60 °C	☼ - 90 °C	1400	7,0	**	● (90°)	●	○	✓	-	-	-	-
4	Bed Linen	60 °C	☼ - 60 °C	1400	7,0	**	-	●	○	✓	-	-	-	-
5	Eco Cotton (1)	60 °C	60° C	1400	7,0	270	-	●	○	✓	✓	53	0,82	52,5
			40°C	1400	7,0	220	-	●	○	✓	✓	53	0,97	75
6	Mixed	40 °C	☼ - 40 °C	1000	3,5	**	-	●	○	-	✓	-	-	-
7	Cotton (2)	40 °C	☼ - 60 °C	1400	7,0	220	-	●	○	✓	-	53	0,97	75
8	Synthetics (3)	40 °C	☼ - 60 °C	1200	4,0	195	-	●	○	✓	-	33	0,75	72
9	Coloureds	40 °C	☼ - 40 °C	1400	7,0	**	-	●	○	✓	-	-	-	-
10	Fast 30 min	30 °C	☼ - 30 °C	800	3,0	30	-	●	○	-	✓	71	0,19	29
11	Wool	40 °C	☼ - 40 °C	800	1,5	**	-	●	○	-	✓	-	-	-
12	Dark	30 °C	☼ - 30 °C	800	4,0	**	-	●	○	-	✓	-	-	-
13	Ultradelicates	30 °C	☼ - 30 °C	0	1,0	**	-	●	○	-	✓	-	-	-
14	Duvet	30 °C	☼ - 30 °C	1000	2,0	**	-	●	○	-	✓	-	-	-
	Rinse + Spin	-	-	1400	7,0	**	-	-	○	-	-	-	-	-
	Spin + Drain *	-	-	1400	7,0	**	-	-	-	-	-	-	-	-

● Required dosage ○ Optional dosage

The cycle duration indicated on the display or instruction manual is an estimate based on standard conditions. The actual duration may vary in relation to several factors, such as the temperature and pressure of the incoming water, ambient temperature, amount of detergent, load quantity and type, load balancing and any additional options selected.

1) Test wash cycle in compliance with regulation 1061/2010:
This cycle is designed for normally soiled cotton loads and is the most efficient in terms of both electricity and water consumption; it should be used for garments washable at 60°C or at 40°C. The actual washing temperature may differ from the indicated value.

PRODUCT DESCRIPTION

- 1. Worktop
- 2. Detergent dispenser
- 3. Control panel
- 4. Door handle
- 5. Door
- 6. Water filter
- 7. Adjustable feet (4)

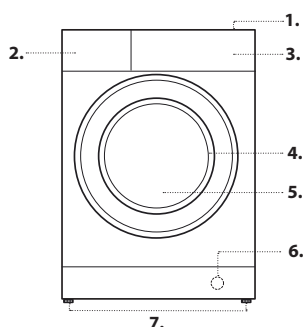

For all testing institutes:

- 2) Long cotton cycle: set cycle 7 at a temperature of 40°C.
- 3) Long synthetics cycle: set cycle 8 at a temperature of 40°C.

* By selecting the cycle and excluding the spin cycle, the washing machine will drain only.

** The duration of the wash cycles can be checked on the display.

DETERGENT DISPENSER

Compartment 1: Pre-wash detergent (powder)

Compartment 2: Washing detergent (powder or liquid)

Compartment 3: Additives (fabric softeners, etc.)

The fabric softener must not exceed the "MAX" level.

! Use powder detergent for white cotton garments, for pre-washing, and for washing at temperatures over 60°C.

! Follow the instructions given on the detergent packaging.

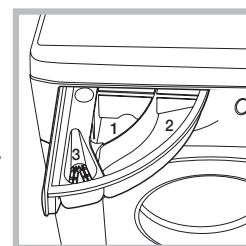

PROGRAMMES

Follow the instructions on the symbols of the garment's wash care label. The value indicated in the symbol is the maximum recommended temperature for washing the garment.



Anti Stain 100

This cycle is suitable to heavily-soiled garments with resistant colours. It ensures a washing class that is higher than the standard class (A class). When running the programme, do not mix garments of different colours. We recommend the use of powder detergent. Pre-treatment with special additives is recommended if there are obstinate stains

Anti Stain Quick

This cycle is ideal for washing daily stains in 45'. It is ideal for mixed fabrics and coloured garments.

White

For washing normally to heavily soiled towels, underwear, table and bed linen, etc in resilient cotton and linen. Only when the temperature is selected at 90°C the cycle is provided with a prewash phase before main washing phase. In this case it is recommended to add detergent both, in the prewash and main wash section.

Bed Linen

For washing home linen in a single cycle. It optimises the use of fabric softener and allows for saving time and electricity. We recommend the use of powder detergent.

Eco Cotton

Suitable for washing moderately soiled cotton garments. At 40°C and 60°C it is the standard cycle for washing cotton garments, and is the most efficient in terms of combined water and electricity consumption.

Mixed

To wash mixed and coloured items together.

Cotton

Suitable for washing towels, underwear, table cloths, etc. made of resistant linen and cotton that are moderately to heavily soiled.

Synthetics

Suitable for washing moderately soiled garments made of synthetic fibres (e.g. polyester, polyacrylic, viscose, etc.) or mixed synthetic-cotton fibres.

Coloureds

For washing coloured cotton garments. This programme is optimised to keep colours bright even after repeated washing.

Fast 30 min

For washing lightly soiled garments in a short time. Not suitable for wool, silk and garments to be washed by hand.

Wool - Woolmark Apparel Care - Green:

The Wool wash cycle of this machine has been approved by The Woolmark Company for the washing of wool garments labelled as "hand wash" provided that the products are washed according to the instructions on the garment label and those issued by the manufacturer of this washing machine (M1126). The Woolmark logo is a Certification mark in many countries.



Dark

For washing dark-coloured garments. The wash cycle is designed to preserve dark colours over time.

We recommend using a liquid detergent for best results, preferably when washing dark-coloured garments.

Ultradelicates

For washing very delicate garments. It is advisable to turn the garments inside out before washing them. For best results, use liquid detergent on delicate garments.

Duvet

Suitable for washing clothing padded with goose down, such as single duvets (weighing under 2 kg), cushions or down jackets. Duvets should be loaded into the drum with their edges folded inwards and no more than ¾ of the total drum volume should be used up. For best results, it is advisable to use liquid detergent to be poured into the detergent drawer.

Rinse + Spin

Designed for rinsing and spinning.

Spin + Drain

Designed for spinning and draining the water.

FIRST TIME USE

To remove any manufacturing debris select the **3** programme at a temperature of 90°C. Pour a small quantity of detergent powder into the main wash **2** compartment of the detergent dispenser (maximum 1/3 of the quantity the detergent manufacturer recommends for lightly soiled laundry). Start the programme **without adding any laundry**.

DAILY USE

Prepare your laundry according to the recommendations in the "HINTS AND TIPS" section. Load the laundry, close the door, open the water tap and press the "ON/OFF" button to switch the washing machine on, the "Start/Pause" button flashes. Turn the programme selector to the desired programme and select any option if needed. The temperature and spin speed can be changed by pressing the "Temp." button or the "Spin

Speed" button. Pull out the detergent dispenser and add the detergent (and additives/softener) now. Observe the dosing recommendations on the detergent pack. Then close the detergent dispenser and press the "Start/Pause" button. The "Start/Pause" button will light up and the door will be locked.

PAUSE A RUNNING PROGRAMME

To pause the wash cycle, press the "Start/Pause" button; the indicator light will go off and the remaining time on display flash. To start the wash cycle from the point at which it was interrupted press the button again.

OPEN THE DOOR, IF REQUIRED

After starting a programme, the "Door locked" indicator lights up to show that the door can not be opened. As long as a wash programme is running, the door remains locked. To open the door while a programme is in progress, press the "Start/Pause" button to pause the programme. Provided the water level and/or temperature is/are not too high, the "Door locked" indicator light goes off and you can open the door. For example to add or remove laundry. Press the "Start/Pause" button again to continue the programme.

PROGRAMME END

The "Door locked" indicator light goes off and the display shows "End". To switch off the washing machine after programme ends press the "ON/OFF" button, the lights goes off. If you do not press "ON/OFF" button, the washing machine will switch off automatically after about a half of an hour. Close the water tap, open the door and unload the washing machine. Leave the door ajar to allow the drum to dry.

OPTIONS

! If the selected option is incompatible with the programme set, the incompatibility will be signalled by a buzzer (3 beeps) and the corresponding indicator light will flash.

! If the selected option is incompatible with another previously set option, only the most recent selection will remain active.

Energy saver

This option saves energy by not heating the water used to wash your laundry – an advantage both to the environment and to your energy bill. Instead, intensified wash action and water optimisation ensure great wash results in the same average time of a standard cycle. For the best washing results we recommend the usage of a liquid detergent.

Start Delay

To set the selected programme to start at a later time, press the button to set the desired delay time. Symbol lights on the display when this function is enabled. To cancel the delayed start, press the button again until the value, "0" is shown on the display.

Multi Rinse

By selecting this option, the efficiency of the rinse is increased and optimal detergent removal is guaranteed. It is particularly useful for sensitive skin. Press the button once, two or three times to select an additional 1, 2 or 3 rinses after the standard cycle rinse and remove all traces of detergent. Press the button again to go back to the "Normal rinse" rinse type.

Cleaning Action

Option "Cleaning Action" makes it possible to optimise washing based on the level of soil in the fabrics and on desired wash cycle intensity. For heavily-soiled garments press "Cleaning Action" button until the level is reached. This level ensures a high-performance wash due to a larger quantity of water used in the initial phase of the cycle and due to increased drum rotation. It is useful when removing the most stubborn stains. For lightly-soiled garments or a more delicate treatment of the fabrics, press "Cleaning Action" button until the level is reached. The cycle will reduce drum rotation to ensure washing results that are perfect for delicate garments.



Temperature

Every programme has a predefined temperature. If you want to change the temperature, press the "Temp." button. The value appears on the display.

Spin Speed

Every programme has a predefined spin speed. If you want to change the spin speed, press the "Spin Speed" button. The value appears on the display.

KEY LOCK

To lock the control panel, press and hold the “Energy saver” button for approximately 3 seconds. The symbol  will light up on the display to indicate that the control panel has been locked (with the exception of the “ON/OFF”  button). This prevents unintentional changes to programmes, especially with children near the machine. To unlock the control panel, press and hold the “Energy saver” button for approximately 3 seconds.

HINTS AND TIPS

Sort your laundry according to

Type of fabric/care label (cotton, mixed fibres, synthetics, wool, handwash items). Colour (separate coloured and white items, wash new coloured items separately). Delicates (wash small items – like nylon stockings – and items with hooks – like bras – in a cloth bag or pillow case with zip).

Empty all pockets

Objects like coins or lighters can damage your laundry as well as the drum.

CLEANING & MAINTENANCE

For any cleaning and maintenance, switch off and unplug the washing machine. Do not use flammable fluids to clean the washing machine.

Cleaning the outside of the washing machine

Use a soft damp cloth to clean the outer parts of the washing machine. Do not use glass or general purpose cleaners, scouring powder or similar to clean the control panel – these substances might damage the printing.



TRANSPORT AND HANDLING

Never lift the washing machine by holding it at the worktop.

Pull out the mains plug, and close the water tap. Make sure that door and detergent dispenser are properly closed. Disconnect the inlet hose from the water tap, and remove the drain hose from your draining point. Remove all rest water from the hoses, and fix them so that they cannot get damaged during transport. Refit the transport bolts. Follow the instructions for removing the transport bolts in the Installation Guide in reverse order.

TROUBLESHOOTING

The washing machine may sometimes not work properly for certain reasons. Before calling the After-sales service, it is recommended to check to see if the problem can be easily resolved using the following list.

Anomalies:	Possible causes / Solution:
The washing machine does not turn on.	<ul style="list-style-type: none"> The plug is not inserted into the electrical outlet, or not enough to make contact. There has been a power failure.
The wash cycle does not start.	<ul style="list-style-type: none"> The door is not fully closed. The "ON/OFF"  button has not been pressed. The "Start/Pause"  button has not been pressed. The water tap is not open. A "Start Delay" has been set.
The washing machine does not fill with water (the message "h2o" is shown on the display).	<ul style="list-style-type: none"> The water intake hose is not connected to the tap. The hose is bent. The water tap is not open. The mains water supply has been shut off. There is not enough pressure. The "Start/Pause"  button has not been pressed.
The washing machine loads and drains water continuously.	<ul style="list-style-type: none"> The drain hose has not been installed at 65 to 100 cm from the ground. The end of the drain hose is immersed in water. The drain connector on the wall does not have an air vent. If the problem persists after having performed these checks, close the water tap, shut off the washing machine, and call the After-sales service. If the dwelling is located on one of the uppermost floors of a building, a siphon effect can sometimes occur, thus causing the washing machine to load and drain water continuously. Special anti-siphon valves are available on the market to prevent these types of problems.
The washing machine does not drain or does not spin.	<ul style="list-style-type: none"> The programme does not include the draining function: with certain programmes it must be activated manually. The drain hose is bent. The drain line is obstructed.
The washing machine vibrates excessively during the spin cycle.	<ul style="list-style-type: none"> At the time of installation, the drum was not properly unblocked. The washing machine is not level. The washing machine is squeezed between furniture and the wall.
The washing machine leaks water.	<ul style="list-style-type: none"> The water intake hose has not been tightened properly. The detergent dispenser is clogged. The drain hose has not been properly fastened.
The machine is locked and the display flashes, indicating an error code (e.g. F-01, F-..).	<ul style="list-style-type: none"> Shut off the machine, disconnect the plug from the outlet, and wait about 1 minute before turning it back on. If the problem persists, call the After-sales service.
Too much foam is formed.	<ul style="list-style-type: none"> The detergent is not compatible with the washing machine (it must bear the wording "for washing machines", "for hand washing and washing machines", or something similar). The dosage was excessive.
Door is locked, with or without failure indication, and the programme does not run.	<ul style="list-style-type: none"> Door is locked in case of power breakdown. Programme will continue automatically as soon as the mains is available again. Washing machine is in a standstill. Programme will continue automatically after the origin of the standstill does not persist anymore.

DEMO MODE: to deactivate this function, switch the washing machine OFF. Then press and hold "Start/Pause"  button, within 5 seconds press also "ON/OFF"  button and hold both buttons for 2 seconds.

CLEANING & MAINTENANCE

**For any cleaning and maintenance, switch off and unplug the washing machine.
Do not use flammable fluids to clean the washing machine.**

CLEANING THE OUTSIDE OF THE WASHING MACHINE

Use a soft damp cloth to clean the outer parts of the washing machine.

Do not use glass or general purpose cleaners, scouring powder or similar to clean the control panel – these substances might damage the printing.

CHECKING THE WATER SUPPLY HOSE

Check the inlet hose regularly for brittleness and cracks. If damaged, replace it by a new hose available through our After-Sales Service or your specialist dealer. Depending on the hose type:

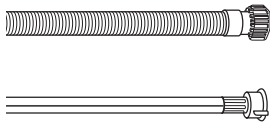

If the inlet hose has a transparent coating, periodically check if the colour intensifies locally. If yes, the hose may have a leak and should be replaced.

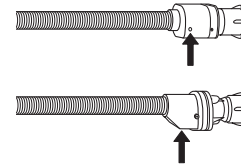

For water stop hoses: check the small safety valve inspection window (see arrow). If it is red, the water stop function was triggered, and the hose must be replaced by a new one. For unscrewing this hose, press the release button (if available) while unscrewing the hose.

CLEANING THE MESH FILTERS IN THE WATER SUPPLY HOSE

1. Close water tap and unscrew the inlet hose.

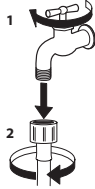

2. Clean the mesh filter at the hose's end carefully with a fine brush.

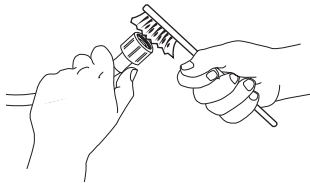

3. Now unscrew the inlet hose on the back of the washing machine by hand. Pull out the mesh filter from the valve on the back of the washing machine with pliers and carefully clean it.

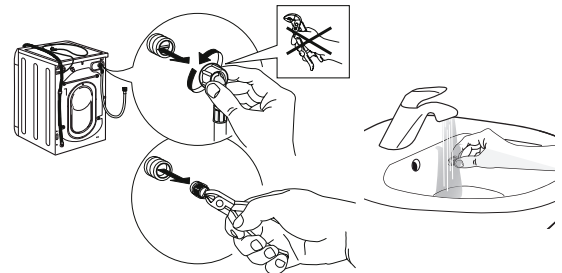

4. Insert the mesh filter again. Connect the inlet hose to water tap and washing machine again. Do not use a tool to connect the inlet hose. Open the water tap and check that all connections are tight.

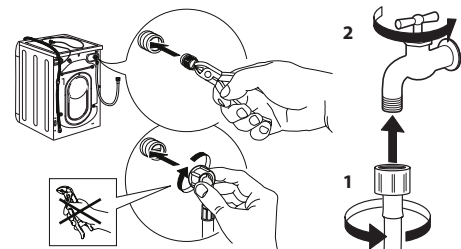

CLEANING THE DETERGENT DISPENSER

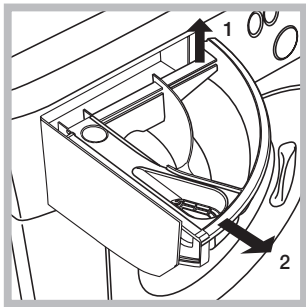

Remove the dispenser by raising it and pulling it out (see figure). Wash it under running water; this operation should be repeated frequently.

CLEANING THE WATER FILTER / DRAINING RESIDUAL WATER

Switch off and unplug the washing machine before cleaning the water filter or draining residual water. If you used a hot wash programme, wait until the water has cooled down before draining any water. Clean the water filter regularly, to avoid that the water cannot drain after the wash due to obstruction of the filter. If the water cannot drain, the display indicates that the water filter may be clogged.

1. Container for the drained water:
Place a low and wide container under the water filter in order to collect the residual water.

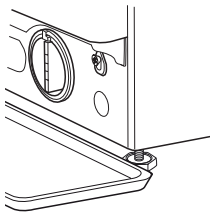

2. Drain the water:
Slowly turn the filter counter-clockwise until all the water has come out. Allow the water to flow out without removing the filter. Once the container is full, close the water filter by turning it clockwise. Empty the container. Repeat the procedure until all the water has been drained.

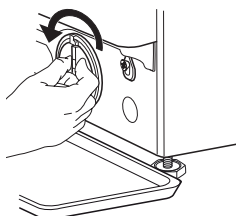

3. Remove filter: Lay a cotton cloth beneath the water filter, which can absorb a small amount of rest water. Then remove the water filter by turning it out anticlockwise.

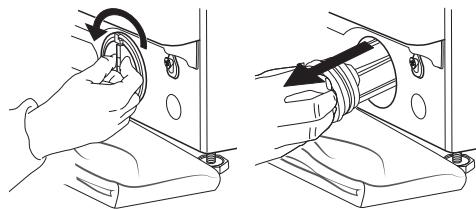

4. Clean the water filter: remove residues in the filter and clean it under running water.

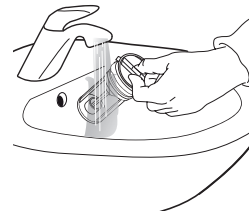

5. Insert the water filter: Reinsert the water filter again by turning it in clockwise direction. Make sure to turn it in as far as it goes; the filter handle must be in vertical position. To test water tightness of the water filter, you can pour about 1 liter of water into the detergent dispenser.

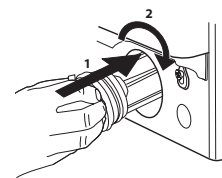

TRANSPORT AND HANDLING

Never lift the washing machine by holding it at the worktop.

1. Pull out the mains plug, and close the water tap.
2. Make sure that door and detergent dispenser are properly closed.
3. Disconnect the inlet hose from the water tap, and remove the drain hose from your draining point. Remove all rest water from the hoses, and fix them so that they cannot get damaged during transport.
4. Refit the transport bolts. Follow the instructions for removing the transport bolts in the "Installation Guide" in reverse order.

Important: Do not transport the washing machine without having fixed the transport bolts.

AFTER-SALES SERVICE

BEFORE CALLING THE AFTER-SALES SERVICE

1. See if you can solve the problem by yourself with the help of the suggestions given in the **TROUBLESHOOTING**

IF AFTER THE ABOVE CHECKS THE FAULT STILL OCCURS, GET IN TOUCH WITH THE NEAREST AFTER-SALES SERVICE

To receive assistance, call the number shown on the warranty booklet or follow the instructions on the website

<http://docs.hotpoint.eu>.

When contacting our Client After sales service, always specify:

- a brief description of the fault;
- the type and exact model of the appliance;

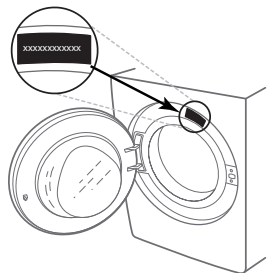

2. Switch the appliance off and back on again to see if the fault persists.

- the service number (number after the word Service on the rating plate).

SERVICE 0000 000 00000



- your full address;
- your telephone number.

If any repairs are required, please contact an authorised after-sales service (to guarantee that original spare parts will be used and repairs carried out correctly).

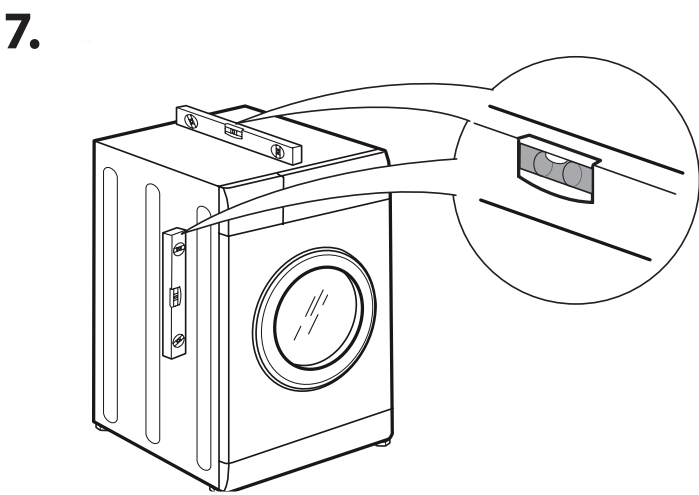
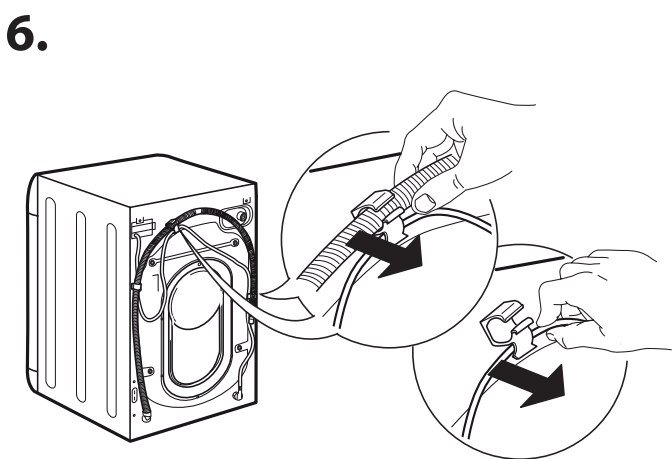
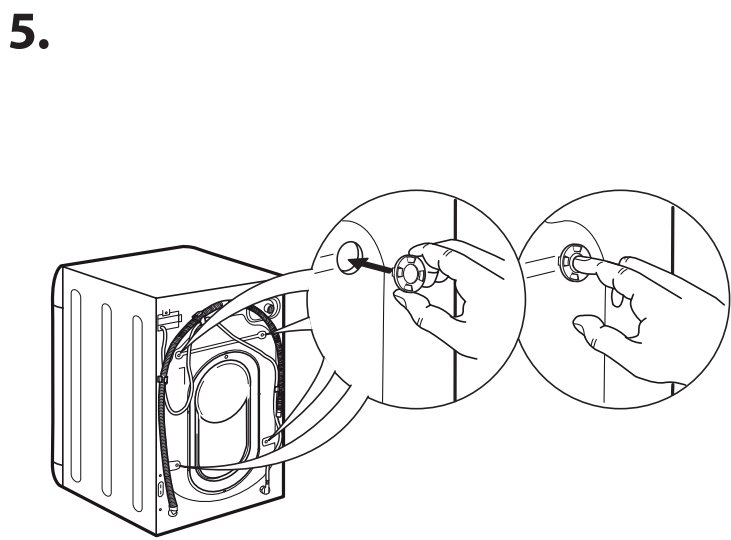
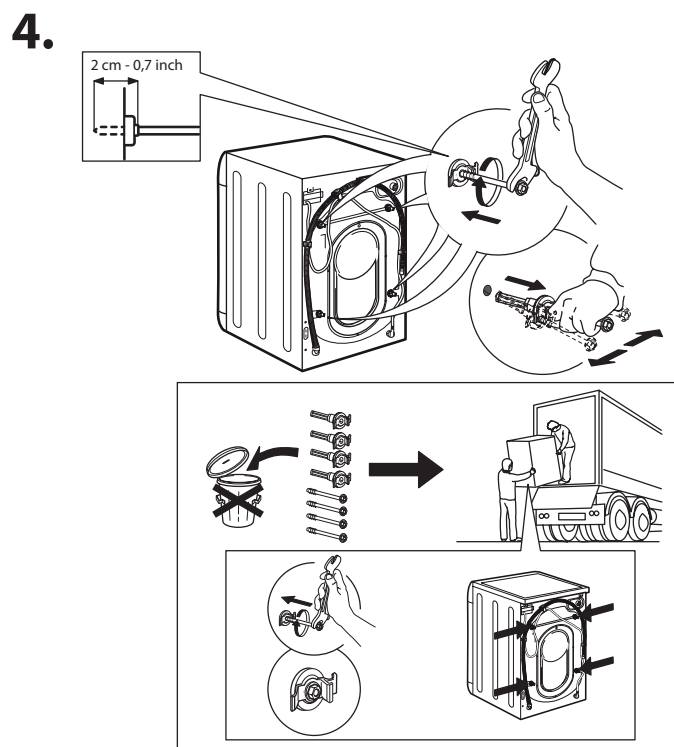
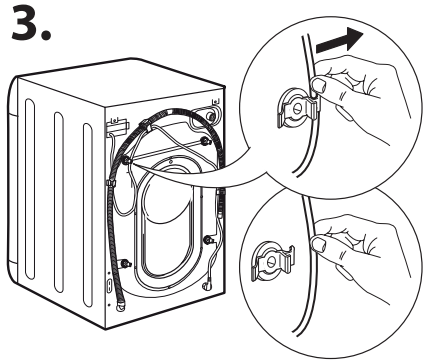
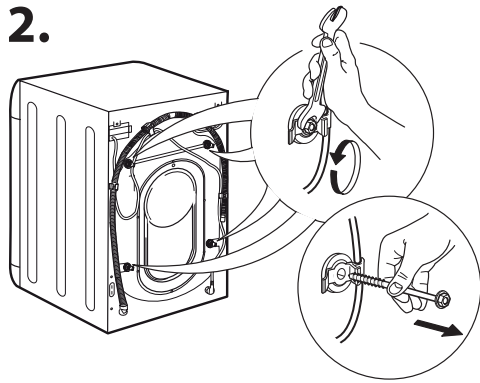
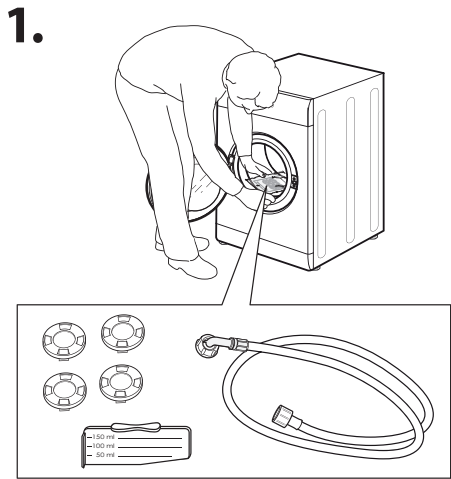
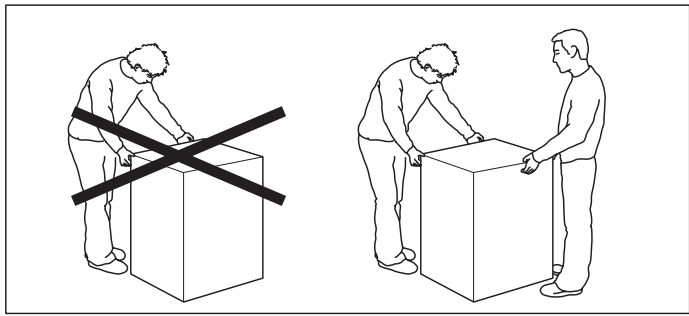

8.

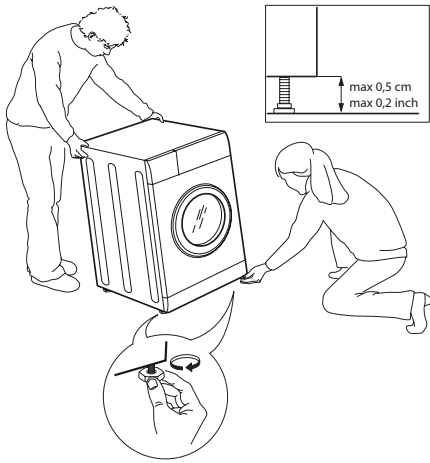

9.

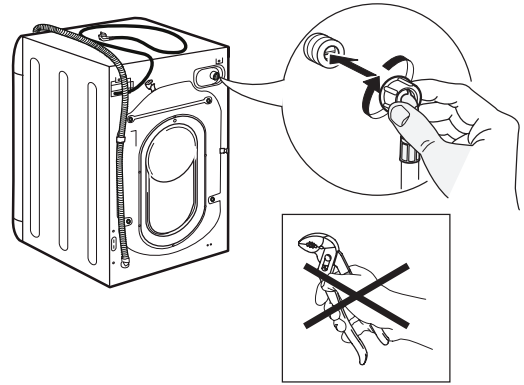

10.



11.



12.



13.

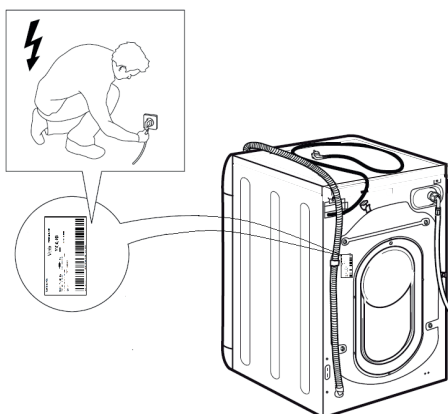

14.



SAFETY INSTRUCTIONS

IMPORTANT TO BE READ AND OBSERVE

Before using the appliance, read these safety instructions. Keep them nearby for future reference. These instructions and the appliance itself provide important safety warnings, to be observed at all times. The manufacturer declines any liability for failure to observe these safety instructions, for inappropriate use of the appliance or incorrect setting of controls.

⚠ Very young children (0-3 years) should be kept away from the appliance. Young children (3-8 years) should be kept away from the appliance unless continuously supervised. Children from 8 years old and above and persons with reduced physical, sensory or mental capabilities or lack of experience and knowledge can use this appliance only if they are supervised or have been given instructions on safe use and understand the hazards involved. Children must not play with the appliance. Cleaning and user maintenance must not be carried out by children without supervision. Never open the door forcibly or use it as a step.

PERMITTED USE

⚠ **CAUTION:** The appliance is not intended to be operated by means of an external switching device, such as a timer, or separate remote controlled system.

⚠ This appliance is intended to be used in household and similar applications such as: staff kitchen areas in shops, offices and other working environments; farm houses; by clients in hotels, motels, bed & breakfast and other residential environments.

⚠ Do not load the machine above the maximum capacity (kg of dry cloth) indicated in the programme table.

⚠ This appliance is not for professional use. Do not use the appliance outdoors.

⚠ Do not use any solvents (e.g. turpentine, benzene), detergents containing solvents, scouring powder, glass or general purpose cleaners, or flammable fluids; do not machine wash fabrics that have been treated with solvents or flammable liquids.

INSTALLATION

⚠ The appliance must be handled and installed by two or more persons - risk of injury. Use protective gloves to unpack and install - risk of cuts.

If you want to stack a dryer on top of your washing machine, first contact our After-Sales Service or your specialist dealer to verify whether this is possible. This is only possible if the dryer is attached to the washing machine by means of appropriate stacking kit available through our After-Sales Service or your specialist dealer.

⚠ Move the appliance without lifting it by the worktop or top lid.

⚠ Installation, including water supply (if any) and electrical connections and repairs must be carried out by a qualified technician. Do not repair or replace any part of the appliance unless specifically stated in the user manual. Keep children away from the installation site. After unpacking the appliance, make sure that it has not been damaged during transport. In the event of problems, contact the dealer or your nearest After-sales Service. Once installed, packaging waste (plastic, styrofoam parts etc.) must be stored out of reach of children - risk of suffocation. The appliance must be disconnected from the power supply before any installation operation - risk of electric shock. During installation, make sure the appliance does not damage the power cable - risk of fire or electric shock. Only activate the appliance when the installation has been completed.

⚠ Do not install your appliance where it may be exposed to extreme conditions, such as: poor ventilation, temperatures below 5 °C or above 35 °C.

⚠ When installing the appliance make sure that the four feet are stable and resting on the floor, adjusting them as required, and check that the appliance is perfectly level using a spirit level.

⚠ If the appliance is being installed on wood or "floating" floors (certain parquet and laminate materials), secure a 60 x 60 x 3 cm (at least) sheet of plywood to the floor then place the appliance on top of this.

⚠ Connect the water inlet hose(s) to the water supply in accordance with the regulations of your local water company.

⚠ For cold fill only models: do not connect to the hot water supply.

⚠ For models with hot fill: the hot water inlet temperature must not exceed 60 °C.

⚠ The washing machine is fitted with transport bolts to prevent any possible damage to the interior during transport. Before using the machine, it is imperative that the transport bolts are removed. After their removal, cover the openings with the 4 enclosed plastic caps.

⚠ After installation of the device, wait a few hours before starting it so that it acclimates to the environmental conditions of the room.

⚠ Make sure that the ventilation openings in the base of your washing machine (if available on your model) are not obstructed by a carpet or other material.

⚠ Use only new hoses to connect the appliance to the water supply. The old hose-sets should not be reused.

⚠ The supply water pressure must be in the 0.1-1 Mpa range.

ELECTRICAL WARNINGS

⚠ It must be possible to disconnect the appliance from the power supply by unplugging it if plug is accessible, or by a multi-pole switch installed upstream of the socket in accordance with the wiring rules and the appliance must be earthed in conformity with national electrical safety standards.

⚠ Do not use extension leads, multiple sockets or adapters. The electrical components must not be accessible to the user after installation. Do not use the appliance when you are wet or barefoot. Do not operate this appliance if it has a damaged power cable or plug, if it is not working properly, or if it has been damaged or dropped.

⚠ If the supply cord is damaged, it must be replaced with an identical one by the manufacturer, its service agent or similarly qualified persons in order to avoid a hazard - risk of electric shock.

CLEANING AND MAINTENANCE

⚠ **WARNING:** Ensure that the appliance is switched off and disconnected from the power supply before performing any maintenance operation; never use steam cleaning equipment - risk of electric shock.

DISPOSAL OF PACKAGING MATERIALS

The packaging material is 100% recyclable and is marked with the recycle symbol .

The various parts of the packaging must therefore be disposed of responsibly and in full compliance with local authority regulations governing waste disposal.

DISPOSAL OF HOUSEHOLD APPLIANCES

This appliance is manufactured with recyclable or reusable materials. Dispose of it in accordance with local waste disposal regulations. For further information on the treatment, recovery and recycling of household electrical appliances, contact your local authority, the collection service for household waste or the store where you purchased the appliance. This appliance is marked in compliance with European Directive 2012/19/EU, Waste Electrical and Electronic Equipment (WEEE). By ensuring this product is disposed of correctly, you will help prevent negative consequences for the environment and human health.

The symbol  on the product or on the accompanying documentation indicates that it should not be treated as domestic waste but must be taken to an appropriate collection center for the recycling of electrical and electronic equipment.



INSTRUCTIONS FOR THE FITTER

Mounting the wooden panel onto the door and inserting the machine into cabinets:

In the case where the machine must be shipped for final installation after the wooden panel has been mounted, we suggest leaving it in its original packaging. The packaging was designed to make it possible to mount the wooden panel onto the machine without removing it completely (see figures below).

The wooden panel that covers the face of the machine must not be less than **13 mm** in thickness and can be hinged on either the right or left. For the sake of practicality when using the machine, we recommend that the panel be hinged on the same side as the door for the machine itself - the left.

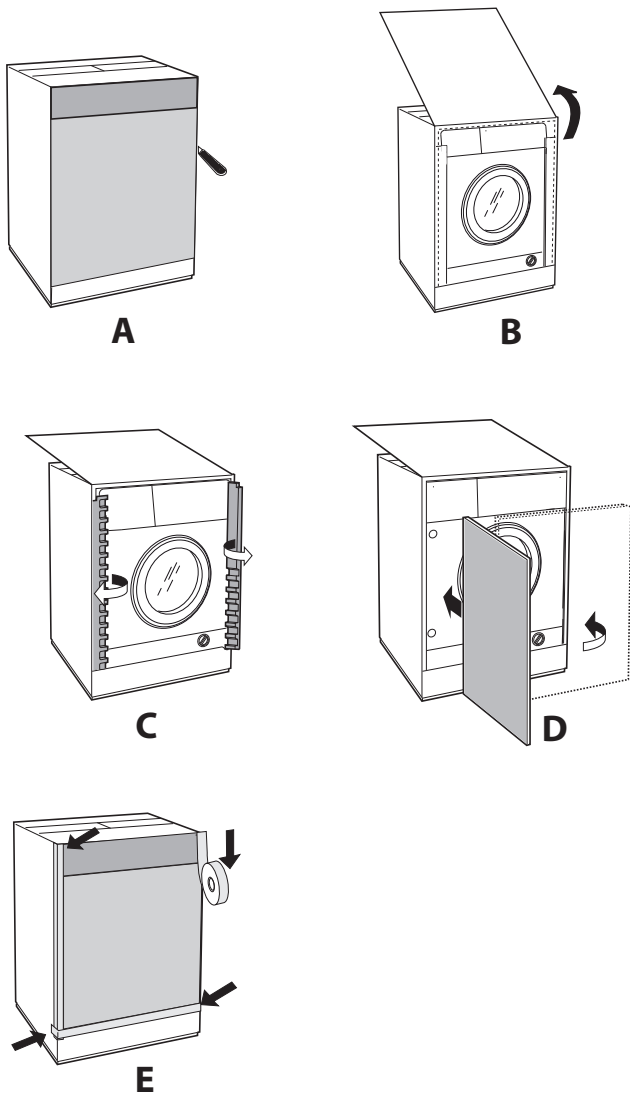

Door Mounting Accessories (Fig. 1-2-3-4-5).

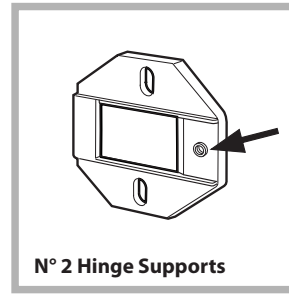

Fig. 1

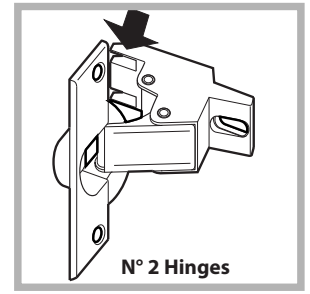

Fig. 2

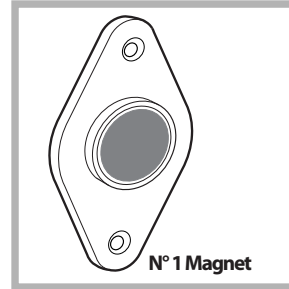

Fig. 3

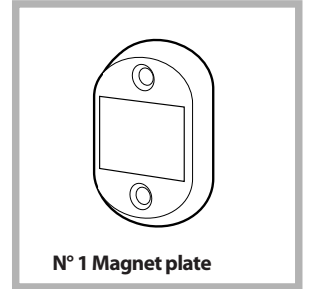

Fig. 4

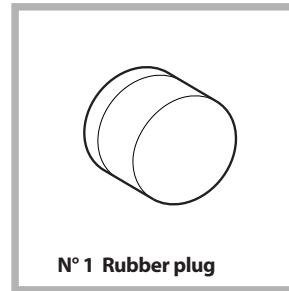

Fig. 5

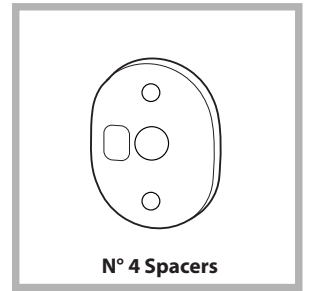

Fig. 4/B

- No. 6 type **A** self-threading screws, $l=13$ mm.
- No. 2 type **B** metric, countersunk screws, $l=25$; for fastening the magnet plate to the cabinet.
- No. 4 type **C** metric screws, $l=15$ mm; for mounting the hinge supports to the cabinet.
- No. 4 type **D** metric screws, $l=7$ mm; for mounting the hinges on the supports.

Mounting the Parts onto the Face of the Machine.

- Fit the hinge supports to the appliance front panel, positioning the hole marked with an arrow in *fig. 1* so that it is on the inner side of the front panel. Fit a spacer (*fig. 4/B*) between the surfaces using type **C** screws.
- Fit the magnet plate at the top of the opposite side, using type **B** screws to fix two spacers (*fig. 4/B*) between the plate and the surface.

Using the Drilling Template.

- To trace the positions of the holes on the left-hand side of the panel, align the drilling template to the top left side of the panel using the lines traced on the extremities as a reference.
- To trace the positions of the holes on the right-hand side of the panel, align the drilling template to the top right side of the panel.
- Use an appropriately sized router to mill the holes for the two hinges, the rubber plug and the magnet.

Moulding the Parts onto the Wooden Panel (Door).

- Insert the hinges into the holes (the movable part of the hinge must be positioned facing away from the panel) and fasten them with the 4 type **A** screws.
 - Insert the magnet into the top hole on the opposite side of the hinges and fasten it with the two type **B** screws.
 - Insert the rubber plug into the bottom hole.
- The panel is now ready to be mounted onto the machine.

Mounting the Panel into the machine.

Insert the nib of the hinge (indicated by the arrow in *fig. 2*) into the hole for the hinge and push the panel towards the front of the machine. Fasten the two hinges with the type **D** screws.

Fastening the plinth guide.

If the machine is installed at the end of a set of modular cabinets, mount either one or both of the guides for the base molding (as shown in *fig. 8*). Adjust them for depth based on the position of the base molding, and, if necessary, fasten the base to the guides (*fig. 9*).

This is how to assemble the plinth guide (*fig. 8*):

Fasten angle **P** using screw **R**, insert plinth guide **Q** into the special slot and once it is in the desired position, lock it in place using angle **P** and screw **R**.

Inserting the machine into the Cabinet.

- Push the machine into the opening, aligning it with the cabinets (*fig. 6*).
- Regulate the adjustable feet to raise the machine to the appropriate height.
- To adjust the position of the wooden panel in both the vertical and horizontal directions, use the **C** and **D** screws, as shown in *fig. 7*.

Important: close the lower part of the appliance front by ensuring that the plinth rests against the floor.

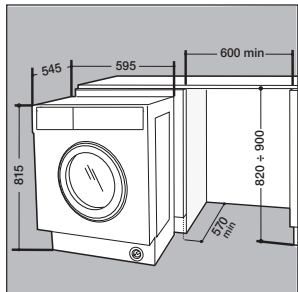

Fig. 6

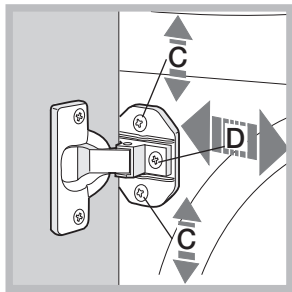

Fig. 7

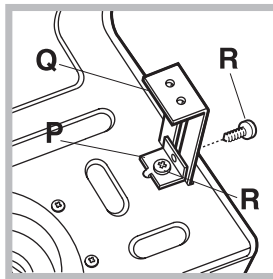

Fig. 8

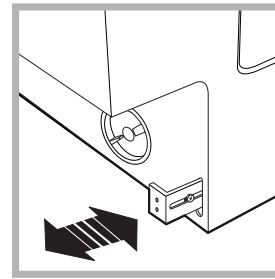

Fig. 9

Accessories provided for the height adjustment.

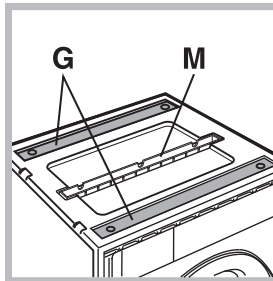

Fig. 10 2 plinth guides (Q)

The following can be found inside the polystyrene lid (*fig. 10*): 2 crossbars (**G**), 1 strip (**M**)

the following can be found inside the appliance drum:

- 4 additional feet (**H**),
- 4 screws (**I**),
- 4 screws (**R**),
- 4 nuts (**L**),

Adjusting the appliance height.

The height of the appliance can be adjusted (from **815 mm** to **835 mm**), by turning the **4** feet.

Should you require the appliance to be placed higher than the above height, you need to use the following accessories to raise it to up to **870 mm**: the two crossbars (**G**); the 4 feet (**H**); the 4 screws (**I**); the 4 nuts (**L**) then perform the following operations (*fig. 11*):

remove the **4** original feet, place a crossbar **G** at the front of the appliance, fastening it in place using screws **I** (screwing them in where the original feet were) then insert the new feet **H**.

Repeat the same operation at the back of the appliance.

Now adjust feet **H** to raise or lower the appliance from **835 mm** to **870 mm**.

Once you have reached the desired height, lock nuts **L** onto crossbar **G**.

To adjust the appliance to a height between **870 mm** and **900 mm**, you need to mount strip **M**, adjusting feet **H** to the required height.

Insert the strip as follows:

loosen the three screws **N** situated at the front of the Top cover of the appliance, insert strip **M** as shown in *fig. 12*, then fasten screws **N**.

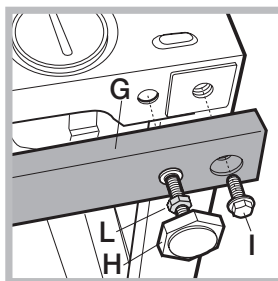

Fig. 11

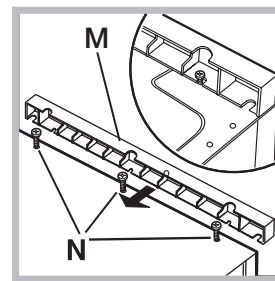

Fig. 12